

Circle S 80

► suspension lamp ► 55 W

PROGETTO
LUCE 
Made in Italy 



Corpo: alluminio verniciato a polvere
Fissaggio: sospensione
Ottica: 40°
Alimentazione: 220/240 V
Potenza massima assorbita: 360 pcs x 0,15 W
Temperatura di utilizzo: -30°C + +50°C
Normativa: prodotti in conformità alle vigenti norme Europee

Body: powder-coated aluminium
Fixing: suspension
Optics: 40°
Power supply: 220/240 V
Maximum absorbed power: 360 pcs x 0,15 W
Working temperature: -30°C + +50°C
Norms: products comply European norms



Colori standard
Standard colors



Bianco
White



Nero
Black



Oro
Gold



Colorazione LED standard
Standard LED coloration



Bianco
White
3200°K



Luce per gioielli
Light for jewels
4200° K



Importante!

La temperatura del metallo in prossimità del LED non deve superare il valore di 50°C.

Remarks!

The temperature of the metal near the LED should not exceed 50°C.

Codici:

Code:

Lenti/Lens	40°
Nero / Black	CS80 40 N
Bianco / White	CS80 40 B
Oro / Gold	CS80 40 O



Dissipazione
Passiva

Dissipation
Passive



Lumen
+/- 6716 Lm



IRC/CRI > 80



Specifiche LED
SMD LED 2835

LED type
SMD LED 2835



Dimmerabile
No

Dimmable
No



Garanzia
Circle S 80: 3 anni
Alimentatore: 1 anno

Warranty
Circle S 80: 3 years
Power supply: 1 year



Disegno tecnico
Technical drawing

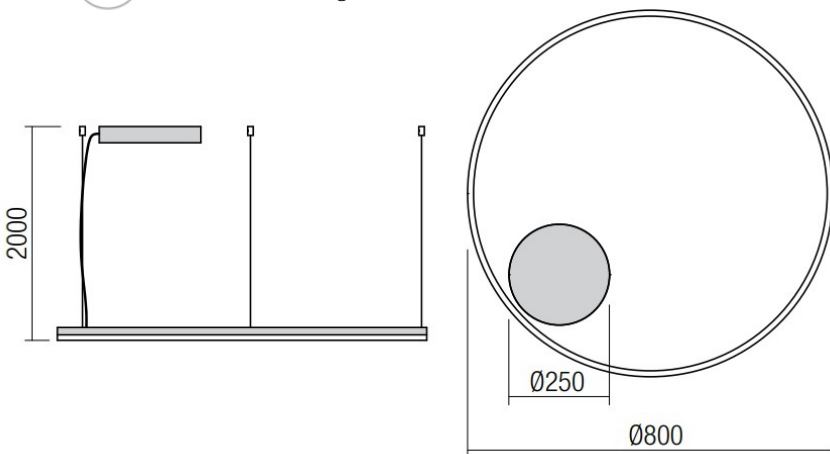

Accessori
Accessories

